

SPECIFICATION

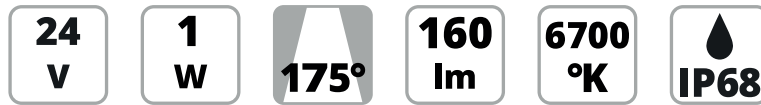

- Support high efficiency above 160lm/W.
- Constant voltage /Constant current
- 175°optic, suitable for 5-25cm depth channel letters & lighting boxes.
- IP68 protection grade, suitable for outdoor applications.
- LM79/LM80 test approved.
- UL/CE approved.

Profile drawings

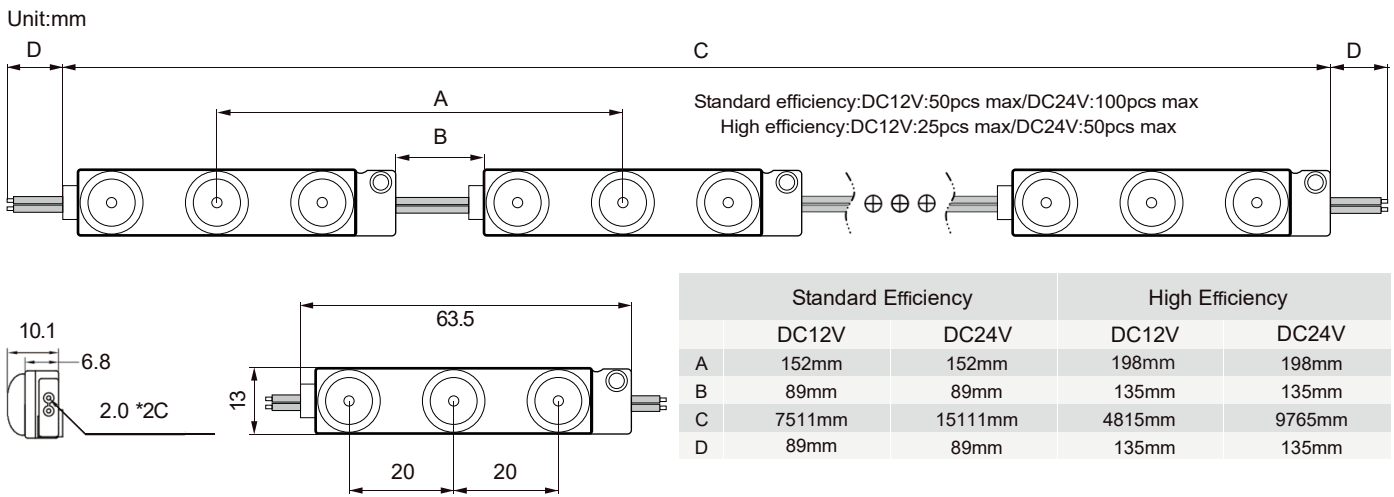

Declaration

The data listed in this product specification are typical values for reference only, specific parameters are subject to the actual measurement report.

All product illustrations in this product specification are schematic drawings, details are subject to the actual received goods.

Light distribution 175°

Light distribution curve

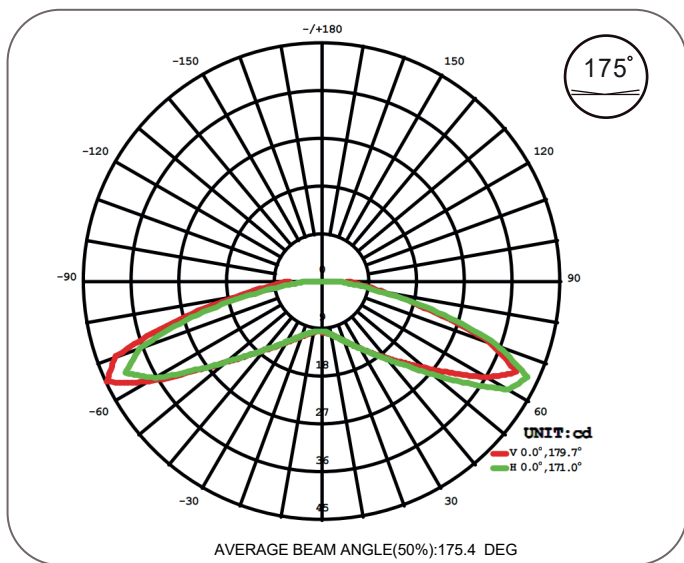

Illumination distribution map

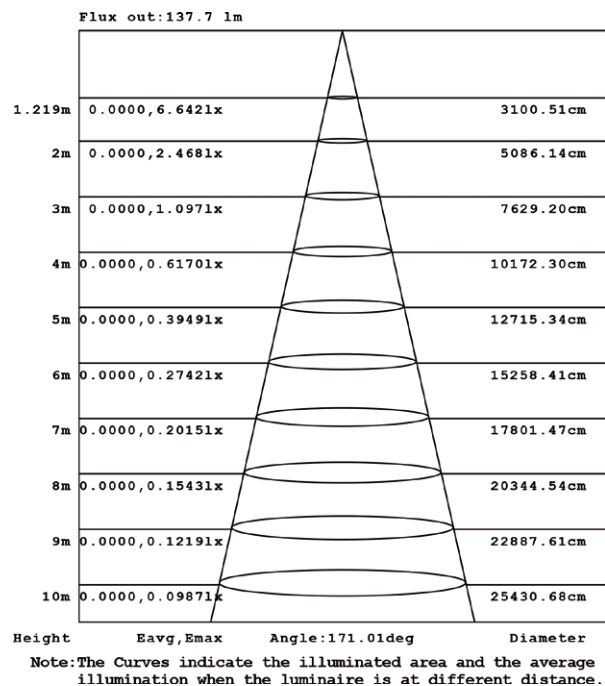

Installation data

Unit: mm



Single row

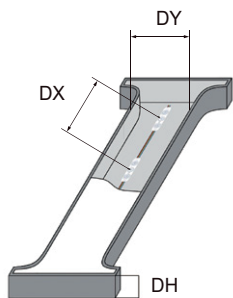

Height (DH)	Standard efficiency		High efficiency	
	Center distance (DX)	Max stroke width (DY)	Center distance (DX)	Max stroke width (DY)
50.8mm	125mm	125mm	125mm	125mm
76.2mm	152mm	178mm	175mm	203mm
101.6mm	152mm	230mm	198mm	280mm
127mm	152mm	305mm	198mm	356mm



Multiple rows

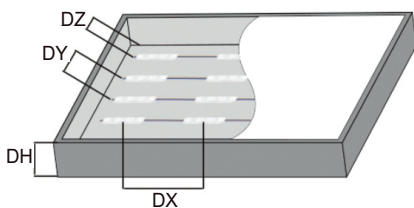

Height (DH)	Standard efficiency		High efficiency	
	Row spacing (DX)	Column spacing (DY)	Row spacing (DX)	Column spacing (DY)
50.8mm	125mm	102mm	125mm	102mm
76.2mm	152mm	152mm	175mm	152mm
101.6mm	152mm	203mm	198mm	203mm
127mm	152mm	254mm	198mm	254mm

Note:

Above data is tested under 5MM white acrylic;

Above test data is tested by 6500K CCT, data of other bins will have variations;

Illuminance of the light box is the average illuminance value under uniform surface of the lightbox;

Installation instruction

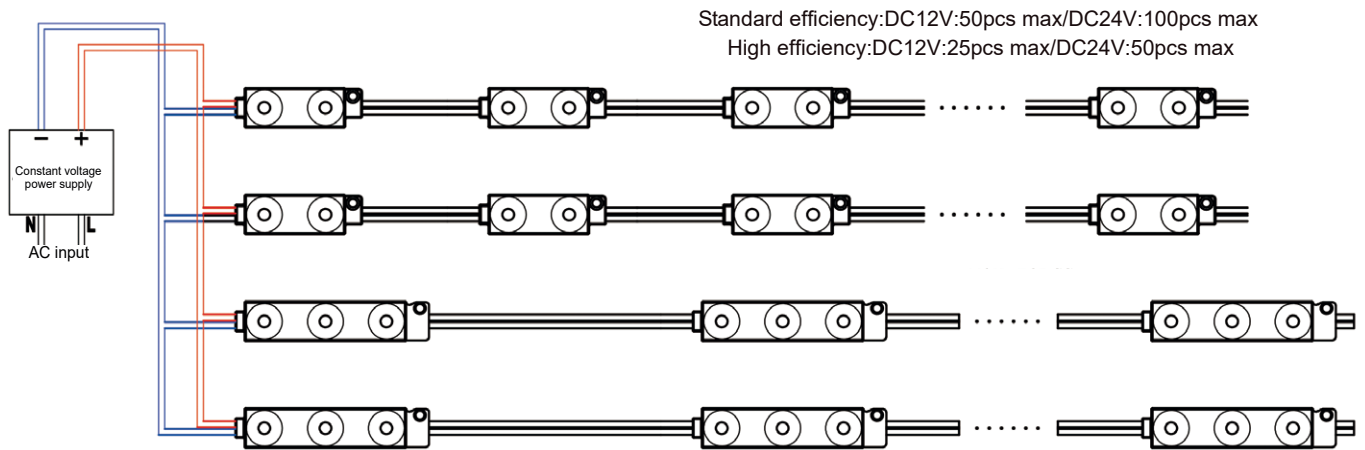

Installation diagram and procedure



Product to be installed

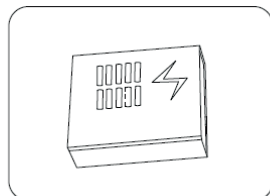

LED power supply

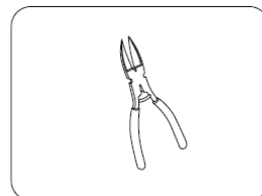

Diagonal pliers

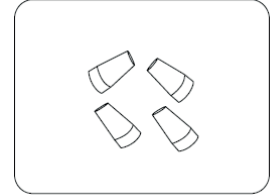

Wiring terminal

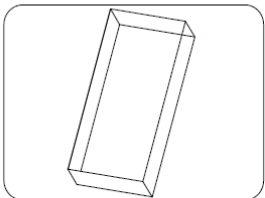

1. Cleaning the installation area

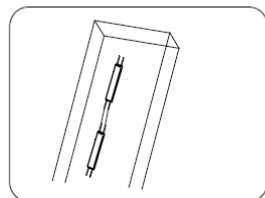

2. Tear the adhesive and paste it

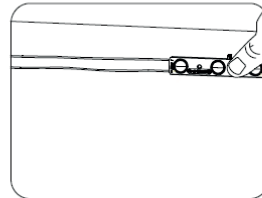

3. Fix products and connect to power

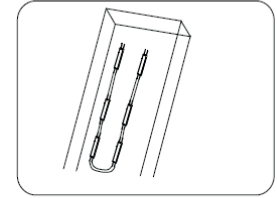

4. Light up for test

Fixing ways

Adhesive tape or screws for fixing